

Model No.: GPCR2450

Description	: Flat Lithium Battery
Chemical System	: Lithium Manganese Dioxide
Nominal Voltage	: 3.0 Volts
Nominal Capacity	: 600mAh
Dimensions	: 24.5 x 5.0 mm
Shelf Life	: 10 years at room temperature
Average Weight	: 6.6g
Application	: Watch, calculator, camera and memory back up.

Cross References:

GP	IEC	JIS	Eveready	Varta
CR2450	CR2450	CR2450	ECR2450	CR2450

Dimension Drawing

Diameter: 24.5mm
Height: 5.0mm

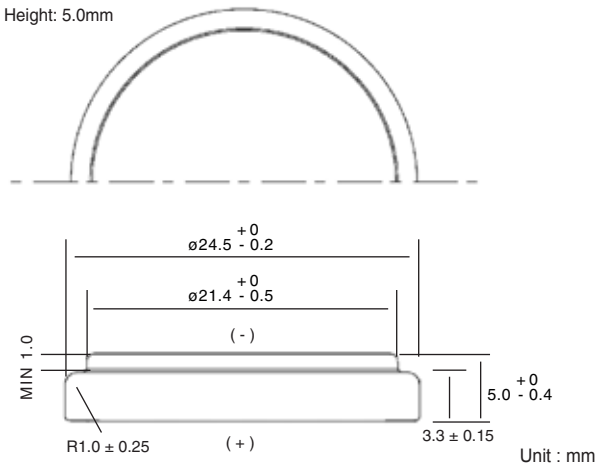

Discharge Characteristics

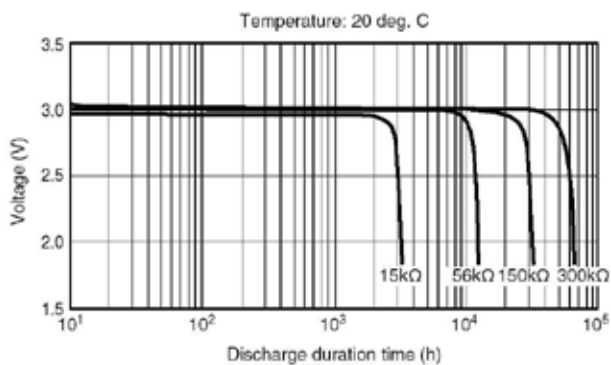

Temperature Characteristics

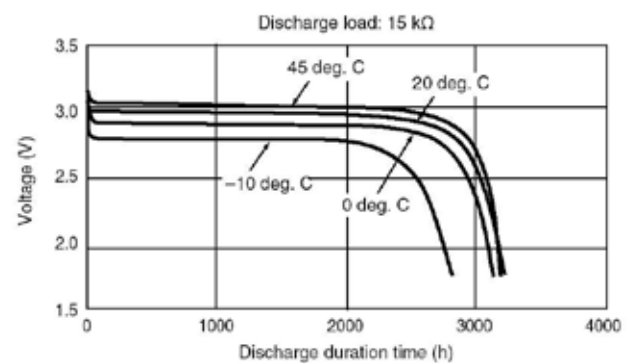

Pulse Discharge Characteristics

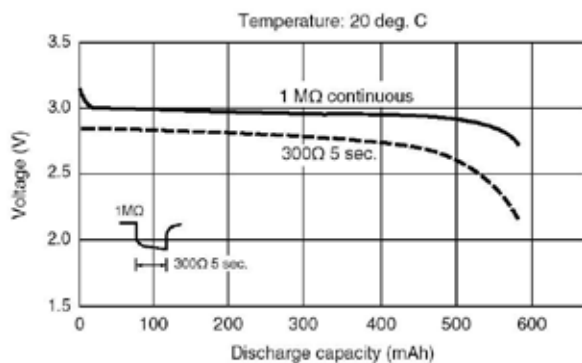

Relationship between Discharge Current and Discharge Capacity

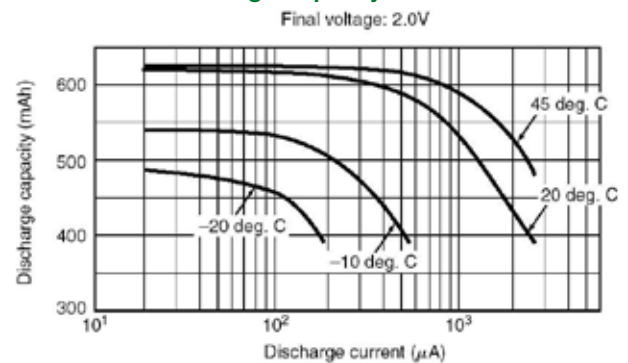

The information (subject to change without prior notice) contained in this document is for reference only and should not be used as a basis for product guarantee or warranty. For applications other than those described here, please consult your nearest GP Sales and Marketing Office or Distributors.